

## Przycisk/wyłącznik wentylatora LTA/LSA

PL Instrukcja montażu

147696-04



**Germany**  
 GEZE Sonderkonstruktionen GmbH  
 Planken 1  
 97944 Boxberg-Schweigern  
 Tel. +49 (0) 7930 9294 0  
 Fax +49 (0) 7930 9294 10  
 E-Mail: sk.de@geze.com  
 GEZE GmbH  
 Niederlassung Süd-West  
 Tel. +49 (0) 7152 203 594  
 E-Mail: leonberg.de@geze.com  
 GEZE GmbH  
 Niederlassung Süd-Ost  
 Tel. +49 (0) 7152 203 6440  
 E-Mail: muenchen.de@geze.com  
 GEZE GmbH  
 Niederlassung Ost  
 Tel. +49 (0) 7152 203 6840  
 E-Mail: berlin.de@geze.com  
 GEZE GmbH  
 Niederlassung Mitte/Luxemburg  
 Tel. +49 (0) 7152 203 6888  
 E-Mail: frankfurt.de@geze.com  
 GEZE GmbH  
 Niederlassung West  
 Tel. +49 (0) 7152 203 6770  
 E-Mail: essen.de@geze.com  
 GEZE GmbH  
 Niederlassung Nord  
 Tel. +49 (0) 7152 203 6600  
 E-Mail: hamburg.de@geze.com  
 GEZE Service GmbH  
 Tel. +49 (0) 1802 923392  
 E-Mail: service-info.de@geze.com

**Austria**  
 GEZE Austria  
 E-Mail: austria.at@geze.com  
 www.geze.at

**Baltic States**  
 GEZE GmbH Baltic States office  
 E-Mail: office-latvia@geze.com  
 www.geze.com

**Benelux**  
 GEZE Benelux B.V.  
 E-Mail: benelux.nl@geze.com  
 www.geze.be  
 www.geze.nl

**Bulgaria**  
 GEZE Bulgaria - Trade  
 E-Mail: office-bulgaria@geze.com  
 www.geze.bg

**China**  
 GEZE Industries (Tianjin) Co., Ltd.  
 E-Mail: chinasales@geze.com.cn  
 www.geze.com.cn  
 GEZE Industries (Tianjin) Co., Ltd.  
 Branch Office Shanghai  
 E-Mail: chinasales@geze.com.cn  
 www.geze.com.cn  
 GEZE Industries (Tianjin) Co., Ltd.  
 Branch Office Guangzhou  
 E-Mail: chinasales@geze.com.cn  
 www.geze.com.cn  
 GEZE Industries (Tianjin) Co., Ltd.  
 Branch Office Beijing  
 E-Mail: chinasales@geze.com.cn  
 www.geze.com.cn

**France**  
 GEZE France S.A.R.L.  
 E-Mail: france.fr@geze.com  
 www.geze.fr

**Hungary**  
 GEZE Hungary Kft.  
 E-Mail: office-hungary@geze.com  
 www.geze.hu

**Iberia**  
 GEZE Iberia S.R.L.  
 E-Mail: info@geze.es  
 www.geze.es

**India**  
 GEZE India Private Ltd.  
 E-Mail: office-india@geze.com  
 www.geze.in

**Italy**  
 GEZE Italia S.r.l.  
 E-Mail: italia.it@geze.com  
 www.geze.it

GEZE Engineering Roma S.r.l.  
 E-Mail: roma@geze.biz  
 www.geze.it

**Poland**  
 GEZE Polska Sp.z o.o.  
 E-Mail: geze.pl@geze.com  
 www.geze.pl

**Romania**  
 GEZE Romania S.R.L.  
 E-Mail: office-romania@geze.com  
 www.geze.ro

**Russia**  
 OOO GEZE RUS  
 E-Mail: office-russia@geze.com  
 www.geze.ru

**Scandinavia – Sweden**  
 GEZE Scandinavia AB  
 E-Mail: sverige.se@geze.com  
 www.geze.se

**Scandinavia – Norway**  
 GEZE Scandinavia AB avd. Norge  
 E-Mail: norge.se@geze.com  
 www.geze.no

**Scandinavia – Denmark**  
 GEZE Danmark  
 E-Mail: danmark.se@geze.com  
 www.geze.dk

**Singapore**  
 GEZE (Asia Pacific) Pte, Ltd.  
 E-Mail: gezesea@geze.com.sg  
 www.geze.com

**South Africa**  
 GEZE Distributors (Pty) Ltd.  
 E-Mail: info@gezesa.co.za  
 www.geze.co.za

**Switzerland**  
 GEZE Schweiz AG  
 E-Mail: schweiz.ch@geze.com  
 www.geze.ch

**Turkey**  
 GEZE Kapi ve Pencere Sistemleri  
 E-Mail: office-turkey@geze.com  
 www.geze.com

**Ukraine**  
 LLC GEZE Ukraine  
 E-Mail: office-ukraine@geze.com  
 www.geze.ua

**United Arab Emirates/GCC**  
 GEZE Middle East  
 E-Mail: gezeme@geze.com  
 www.geze.ae

**United Kingdom**  
 GEZE UK Ltd.  
 E-Mail: info.uk@geze.com  
 www.geze.com

## GEZE GmbH

Reinhold-Vöster-Straße 21–29  
 71229 Leonberg  
 Germany

Tel.: 0049 7152 203 0  
 Fax: 0049 7152 203 310  
 www.geze.com



## Oznaczenie

Przycisk/wyłącznik wentylatora, rama pojedyncza AS 500 biel alpejska, nr mat. 118476.

## Akcesoria

Nazwa	Nr mat.
AS 500 rama do montażu podtynkowego	
▫ pojedyncza	115376
▫ podwójna	115377
▫ potrójna	115378
▫ poczwórna	115379
▫ pięciokrotna	115380
AS 500 puszka natynkowa	
▫ pojedyncza	120503
▫ podwójna	128609
▫ potrójna	133206
Rama pośrednia 55 × 55 do ST 550 biel alpejska	155851
Rama pośrednia 55 × 55 do LS 990 biel alpejska	148997
Rama pośrednia 55 × 55 do LS 990 stal szlachetna	131822
AS 500 osłona BAB	118480
SCT (1-bieg.)	117996

## Odpowiednie programy wyłączników

### Jung

- AS 500
- LS 990 (z ramą pośrednią)
- ST550 (z ramą pośrednią)

### Gira

- Standard 55
- E2
- Event

### Merten

- System M

### Feller

- EDIZIOdue

### Berker

- B3
- B7
- S1

## Dane techniczne

Wariant	Napięcie	Prąd
LTA-LSA	230 V AC	maks. 10 A
Stopień ochrony	IP 40	

## Rysunki wymiarowe

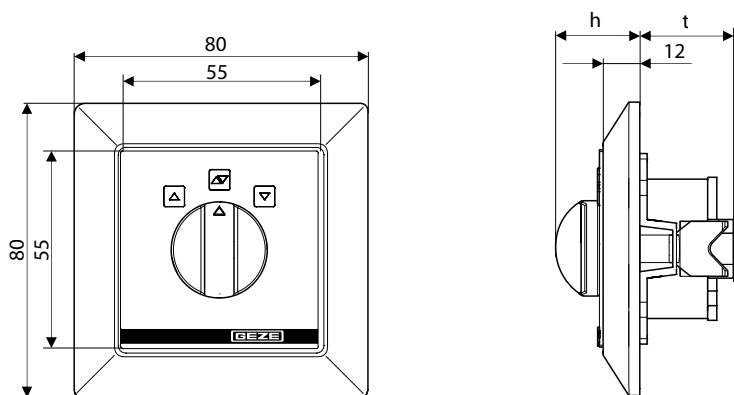

## Rysunek montażowy

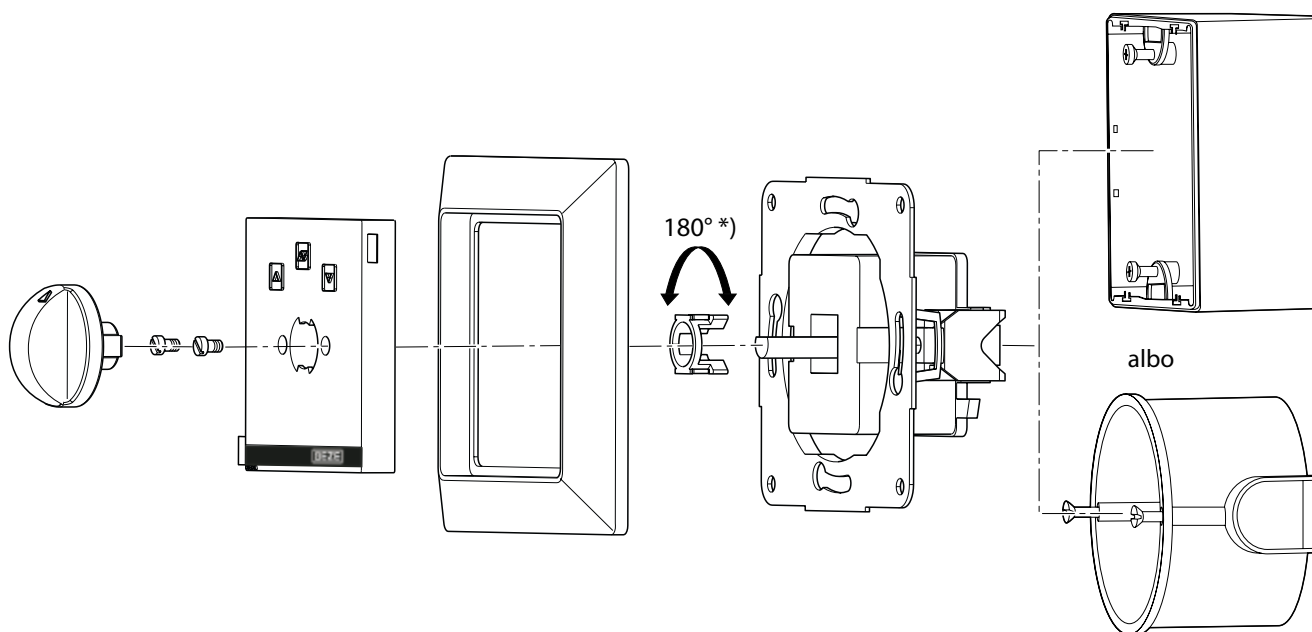

\*) do wyboru mono- albo bistabilny;  
stan wysyłkowy: bistabilny

# Szablon do montażu w słupie



Szablon papierowy może zmieniać wymiary, zależnie od wilgotności powietrza. Dlatego wiążące są tylko dane wymiarowe.

► Przed użyciem szablonu papierowego sprawdzić i ew. skorygować wymiary.

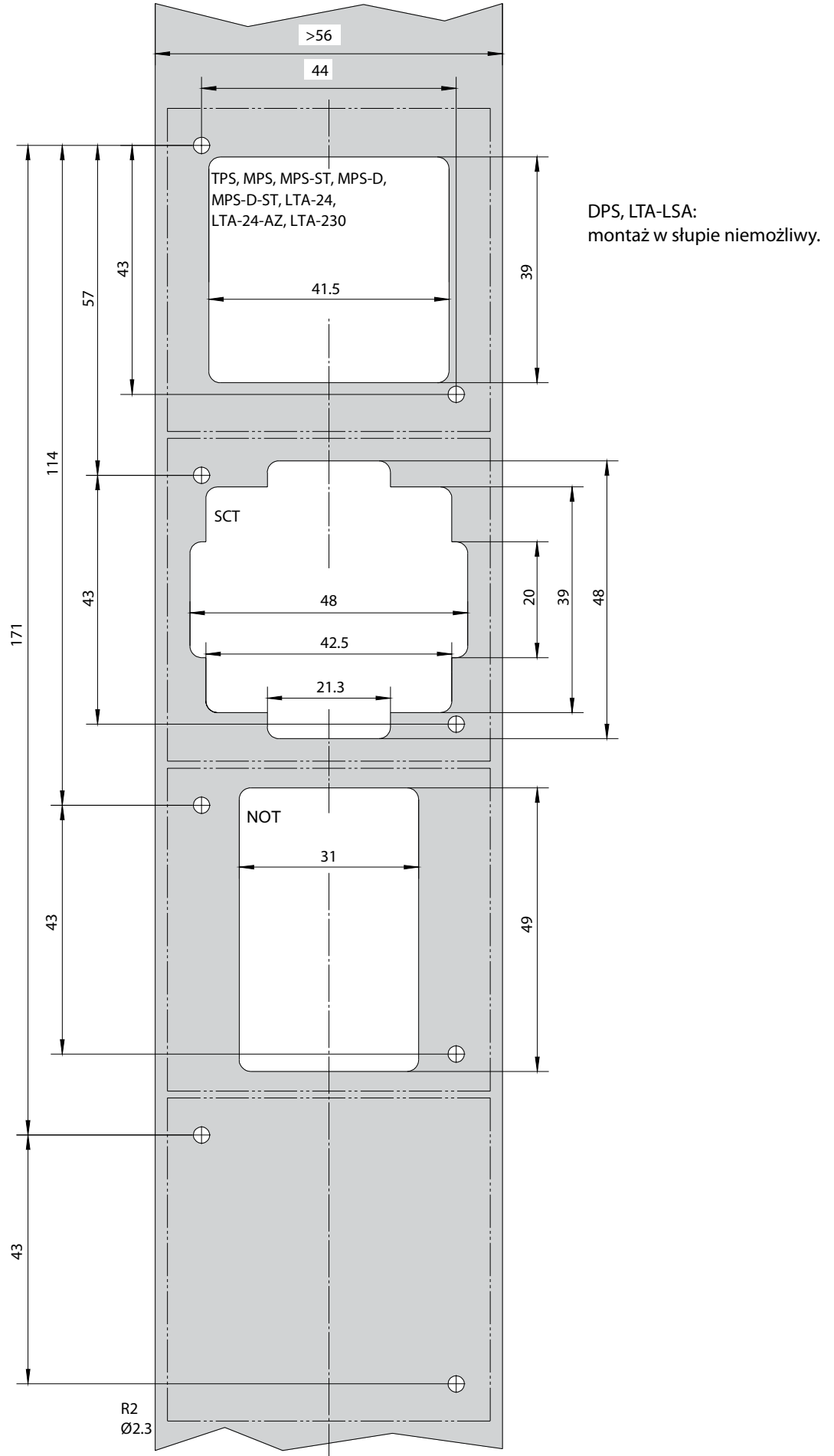

# Schematy elektryczne

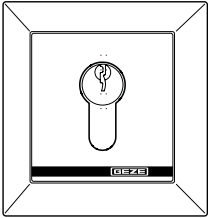
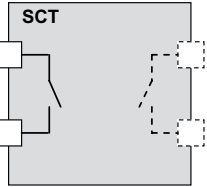
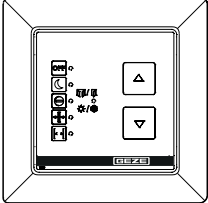
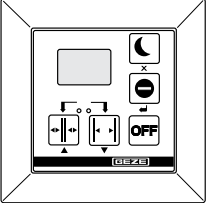
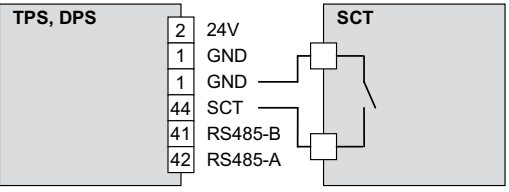
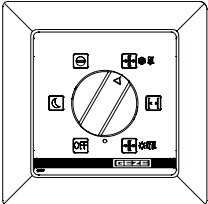
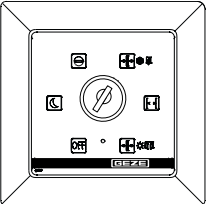
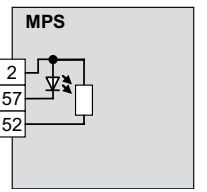
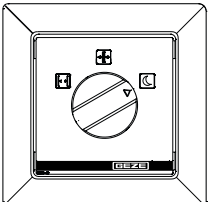
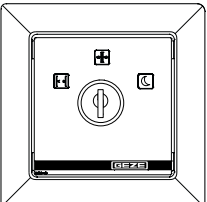
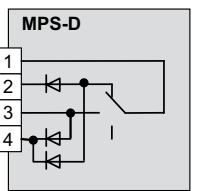
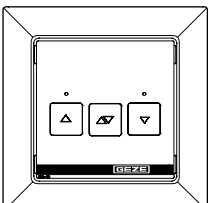
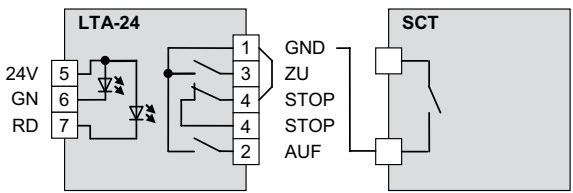
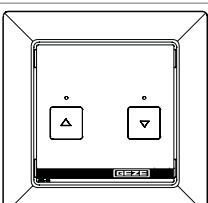
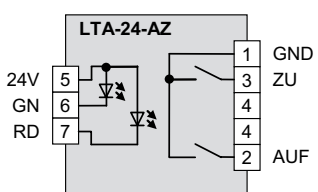
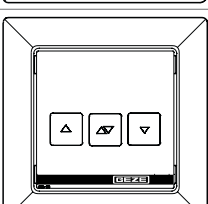
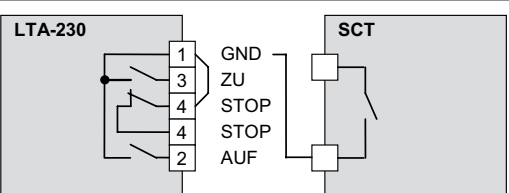
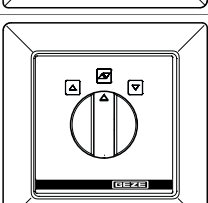
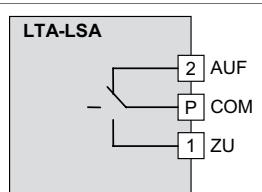
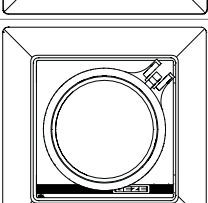
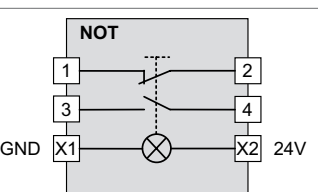
Przycisk	Oznaczenie	Nr mat.	Przycisk	Oznaczenie	Nr mat.	Schemat elektryczny	h [mm]	t [mm]
	SCT (1-bieg.)	117996		-	-		11	31.9
	TPS TPS-SCT TPS-KDT TPS-KDT-SCT DPS z OFF DPS bez OFF DPS z OFF SCT	113231 113232 126582 126583 151524 155809 155810					11.3	5.3 31.9
	MPS	113226		MPS-ST	113227		24	36
	MPS-D	118417		MPS-D-ST	118418		24	36
	LTA-24 LTA-24-SCT	118473 127176					11	26
	LTA-24-AZ	129393					11	26
	LTA-230 LTA-230-SCT	118474 118475					11	26
	LTA-LSA	118476					24	32
	NOT	123132					54	56